

Forged Steel Valves



Valve Specialists™



Gate, Globe & Check



www.upcc.com.ph

ISO 9001



C-13

OMB valves are manufactured in a wide range of materials, supplied by the best available steel mills, forged by well known forgery with outstanding equipment and experience. All the material can be certified in the chemical composition and the mechanical characteristic.

BODY AND BONNET STANDARD MATERIALS				
Materials	Description	Service Recommendations	Casting Eq.	Temperature
ASTM A105	Carbon Steel	General service: oil, oil vapor, gas, steam and water	A216-WCB	-20 to 100F
ASTM A350 LF2	Low Temperature Carbon Steel	Low temperature applications	A352-LCB	-50 to 650F max
ASTM A182 F11	1 1/4% Cr, 1/2% Mo Alloy Steel	To minimize Graphitization	A217-WC6	-20 to 1100F
ASTM A182 F22	2 1/4% Cr, 1% Mo Alloy Steel	For service requiring greater strength than F11	A217-WC9	-20 to 1100F
ASTM A182 F5	5% Cr, 1/2% Mo Alloy Steel	Corrosive/erosive refinery use	A217-C5	-20 to 1100F
ASTM A182 F9	9% Cr, 1% Mo Alloy Steel	Services involving media with higher sulphur content	A217-C12	-20 to 1100F
ASTM A182 F304	18% Cr, 8% Ni Stainless Steel	Corrosive & cryogenic service	A351-CF8	-20 to 1100F
ASTM A182 F316	18% Cr, 8% Ni, 2% Mo Stainless Steel	Superior resistance to corrosion	A351-CF8M	up to 1000F

CHEMICAL COMPOSITION										
BODY AND BONNET MATERIALS										
ASTM Material	C %	Mn %	P %	S %	Si %	Ni %	Cr %	Mo %	Co %	Other
ASTM A105	0.35 max	0.60 1.05	0.040 max	0.050 max	0.35	-	-	-	-	-
ASTM A350 LF2	0.30	0.60 1.35	0.035	0.040	0.15 0.30	-	-	-	-	-
ASTM 182 F5	0.15 max	0.30 0.60	0.030	0.030	0.50 max	0.50 max	4.00 6.00	0.44 0.65	-	-
ASTM 182 F11 (Class 2 & 3)	0.10 0.20	0.30 0.80	0.040	0.040	0.50 1.00	-	1.00 1.50	0.44 0.65	-	-
ASTM 182 F22	0.05 0.15	0.30 0.60	0.040	0.040	0.50 max	-	2.00 2.50	0.87 1.13	-	-
ASTM 182 F304	0.08 max	2.0 max	0.040	0.030	1.00 max	8.00 11.00	18.00 20.00	-	-	-
ASTM 182 F316	0.08 max	2.0 max	0.040	0.030	1.00 max	10.00 14.00	16.00 18.00	2.00 3.00	-	-

ALL VALVES ARE IN STRICT ACCORDANCE WITH THE FOLLOWING STANDARDS			
API 598	- Valve inspection and Test	BS 5352	- Specific for Cast and Forged Steel Wedge Gate, Globe, Check and Plug Valves, Screwed and Socket-Weld
ASME B 16.5	- Steel Pipe Flanges and Fittings	BS 6755	- Testing of valves
ASME B 16.10	- Face-to-Face and End-to-End Dimension of Ferrous Valves	NACE Standard	- Material Requirement - Sulfide Stress Cracking Resistant
ASME B 16.11	- Forged Steel Fittings, Socket-Welding and Threaded	MR 01.75	- Metallic Material for Oil Field Equipment
ASME B 16.34	- Steel Valves, Flanged and Buttwelded Ends	DIN 3202	- End to End dimensions of ferrous valves
MSS SP 25	- Standard Marking System for Valves, Fittings, Flanges and Unions		

Note: these charts are for reference only. OMB recommends customer engineers to analyze service requirements and specify the materials they consider optimum. OMB cannot be held liable for any damage occurred due to the use of the tables.

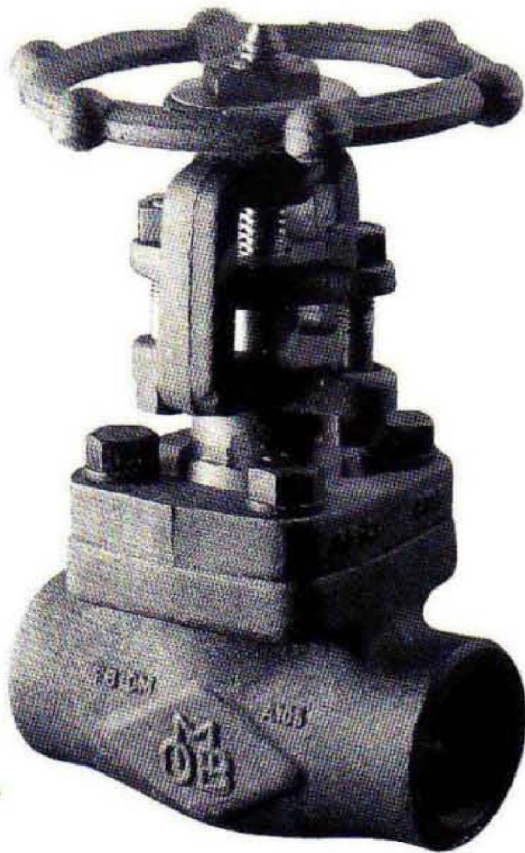

Gate valves are bi-directional valves ideally suited for on-off duties. OMB produces various types both with parallel face gates or with wedge gates. These valves have a very low resistance to flow, which in the case of parallel gate valves approaches that of a straight pipe. They are used for duties with high pressure fluids due to the fact that upstream pressure helps the sealing between gate and seat.

OMB takes great care to study finish of seating surfaces to guarantee their minimum wear under high pressures. Gate valves are supplied in various models to cover the most different and delicate services. The main characteristics of each type are described on pages 13 to 19.

Figure # is identified in each table as:

REGULAR PORT	810	-
FULL PORT	610	1/4
		m ³

To simplify order processing a new computer cataloging code has been introduced.

Example:

FIG.# 810 - SW - 1"

COMPUTER CATALOGING CODE

PROD. LINE	SERVICE	TYPE	CLASS	SIZE	ENDS
A	A	B	8	5	S
↓	↓	↓	↓	↓	↓
Gate OS & Y	Standard	Bolted Bonnet Regular Port	800	1"	Socket Weld

PRODUCT LINE	SERVICE	TYPE	CLASS	SIZE	ENDS
A Gate OS & Y	A Standard	A Bolted Bonnet Full Port	1 150	A 1/8" (DN6)	S Socket Weld (SW)
B Gate IS & Y	B Extended Bonnet	B Bolted Bonnet Regular Port	3 300	1 1/4" (DN8)	N Threaded (NPT)
M Through OS & Y	C Cryogenic	C Welded Bonnet Full Port	6 600	2 3/8" (DN10)	D Socket Weld - Threaded
N Through IS & Y	S Bellows Seal	D Welded Bonnet Regular Port	8 800	3 1/2" (DN15)	E Threaded - Socket Weld
	V Vacuum	E Welded Bonnet Full Penetration Full Port	9 900	4 3/4" (DN20)	B Butt Weld - Standard End to End
		F Welded Bonnet Full Penetration Regular Port	5 1500	5 1" (DN25)	A Butt Weld - Integral End to End B16.10
		M Ring Joint Full Port	B 2000	6 1 1/4" (DN32)	H Butt Weld - Welded End to End B16.10
		N Ring Joint Regular Port	2 2500	7 1 1/2" (DN40)	F Integral Flanges R.F.
		P Round Bolted Bonnet Full Port	C 3000	8 2" (DN50)	G Integral Flanges Grove type
		Q Round Bolted Bonnet Regular Port	4 4500	9 2 1/2"	P Welded on Flanges R.F.
			D 5000	B 3"	Q Welded on Flanges Grove type
			H 6000	C 3 1/2"	M Male Extension API 606
			E 10000	D 4"	L W-D (Reinforced)
			L PN6	E 5"	C CLP - Clamp
			M PN10	F 6"	R BSP - UNI338 (BS21-Rp)
			N PN16	H 8"	T BSP - UNI339 (BS21-Rc)
			P PN25	M 10"	
			Q PN40	P 1 1/16"	
			S PN64	Q 2 1/16"	
			T PN100	R 2 9/16"	
			U PN160	S 3 1/8"	
			V PN250	T 4 1/16"	



RATINGS: Carbon Steel - 1975 p.s.i. @ 100°F

CLASS 800

BOLTED BONNET - REGULAR AND FULL PORT - API 602 - BS 5352
Outside Screw & Yoke - Threaded and Socket Weld Ends

REGULAR PORT	810	-	1/2	3/4	1	1.1/4	1.1/2	2	-
FULL PORT	610	1/4	3/8	1/2	3/4	1	1.1/4	1.1/2	2
		mm in.	mm in.	mm in.	mm in.	mm in.	mm in.	mm in.	mm in.
End to End	A	80 3.14	80 3.14	90 3.54	110 4.33	127 5.00	127 5.00	127 5.00	210 8.26
Handwheel	B	70 2.75	70 2.75	90 3.54	110 4.33	110 4.33	130 5.11	130 5.11	180 7.08
Center to Top Open	C	148 5.86	148 5.86	163 6.41	178 7.00	210 8.26	243 9.56	262 10.3	365 14.3
Dia. of Port	D	8 0.31	10 0.39	14 0.55	19 0.75	24 0.94	30 1.18	37 1.45	48 1.89
Approx. Weight	Kg / Lb	1.6 3.5	1.6 3.5	2.2 4.8	3.5 7.7	5 11	6.5 14.3	9 19.8	21.5 47.3

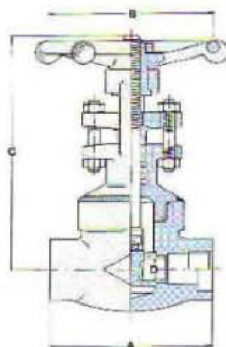

RATINGS: Carbon Steel - 1975 p.s.i. @ 100°F

CLASS 800

WELDED BONNET - REGULAR AND FULL PORT - API 602 - BS 5352
Outside Screw & Yoke - Threaded and Socket Weld Ends

REGULAR PORT	L810	-	1/2	3/4	1	1.1/4	1.1/2	2	-
FULL PORT	L610	1/4	3/8	1/2	3/4	1	1.1/4	1.1/2	2
		mm in.	mm in.	mm in.	mm in.	mm in.	mm in.	mm in.	mm in.
End to End	A	80 3.14	80 3.14	90 3.54	110 4.33	127 5.00	127 5.00	127 5.00	210 8.26
Handwheel	B	70 2.75	70 2.75	90 3.54	110 4.33	110 4.33	130 5.11	130 5.11	180 7.08
Center to Top Open	C	148 5.86	148 5.86	163 6.41	178 7.00	210 8.26	243 9.56	262 10.3	365 14.3
Dia. of Port	D	8 0.31	10 0.39	14 0.55	19 0.75	24 0.94	30 1.18	37 1.45	48 1.89
Approx. Weight	Kg / Lb	1.6 3.5	1.6 3.5	2.2 4.8	3.5 7.7	5 11	6.3 13.8	8 17.6	17 37.4

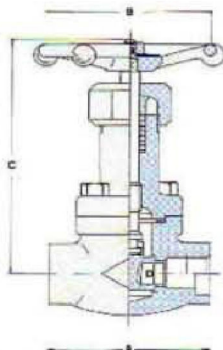

RATINGS: Carbon Steel - 1975 p.s.i. @ 100°F

CLASS 800

BOLTED BONNET - REGULAR AND FULL PORT - API 602
Inside Screw & Yoke - Threaded and Socket Weld Ends

REGULAR PORT	800	-	1/2	3/4	1	1.1/4	1.1/2	2	-
FULL PORT	600	1/4	3/8	1/2	3/4	1	1.1/4	1.1/2	2
		mm in.	mm in.	mm in.	mm in.	mm in.	mm in.	mm in.	mm in.
End to End	A	80 3.14	80 3.14	90 3.54	110 4.33	127 5.00	127 5.00	127 5.00	210 8.26
Handwheel	B	70 2.75	70 2.75	90 3.54	110 4.33	110 4.33	130 5.11	130 5.11	180 7.08
Center to Top Open	C	148 5.86	148 5.86	175 6.88	212 8.34	235 9.25	287 11.3	327 12.9	380 15.0
Dia. of Port	D	8 0.31	10 0.39	14 0.55	19 0.75	24 0.94	30 1.18	37 1.45	48 1.90
Approx. Weight	Kg / Lb	1.5 3.3	1.5 3.3	2 4.4	3 6.6	5.1 11.2	6.7 14.7	9.5 20.9	21.5 47.3

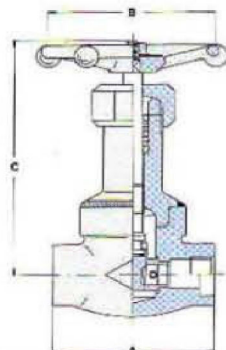

RATINGS: Carbon Steel - 1975 p.s.i. @ 100°F

CLASS 800

WELDED BONNET - REGULAR AND FULL PORT - API 602
Inside Screw & Yoke - Threaded and Socket Weld Ends

REGULAR PORT	L800	-	1/2	3/4	1	1.1/4	1.1/2	2	-
FULL PORT	L600	1/4	3/8	1/2	3/4	1	1.1/4	1.1/2	2
		mm in.	mm in.	mm in.	mm in.	mm in.	mm in.	mm in.	mm in.
End to End	A	80 3.14	80 3.14	90 3.54	110 4.33	127 5.00	127 5.00	127 5.00	210 8.26
Handwheel	B	70 2.75	70 2.75	90 3.54	110 4.33	110 4.33	130 5.11	130 5.11	180 7.08
Center to Top Open	C	148 5.86	148 5.86	175 6.88	212 8.34	235 9.25	287 11.3	327 12.9	380 15.0
Dia. of Port	D	8 0.31	10 0.39	14 0.55	19 0.75	24 0.94	30 1.18	37 1.45	48 1.90
Approx. Weight	Kg / Lb	1.5 3.3	1.5 3.3	2 4.4	3 6.6	5.1 11.2	6.5 14.3	9 19.8	17 37.4

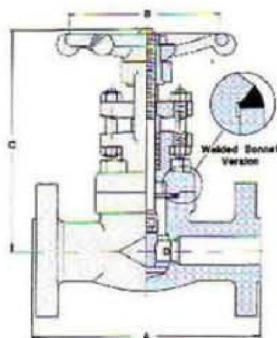

RATINGS: Carbon Steel
 Class 150 - 285 p.s.i. @ 100°F
 Class 300 - 740 p.s.i. @ 100°F
 Class 600 - 1480 p.s.i. @ 100°F

CLASS 150-300-600

BOLTED BONNET - REGULAR PORT - API 602 - BS 5352
 Outside Screw & Yoke - Integral Flanged Ends according to ASME B16.5

REGULAR PORT		1/4		3/8		1/2		3/4		1		1.1/4		1.1/2		2	
		mm	in.	mm	in.	mm	in.	mm	in.	mm	in.	mm	in.	mm	in.	mm	in.
Class 150 F1-810	A	-	-	-	-	108	4.25	118	4.64	127	5.00	-	-	165	6.49	178	7.00
Class 300 F3-810	A	-	-	-	-	140	5.51	153	6.02	165	6.49	-	-	191	7.51	216	8.50
Class 600 F6-810	A	-	-	-	-	165	6.49	191	7.51	216	8.50	-	-	241	9.48	292	11.5
Handwheel	B	-	-	-	-	90	3.54	90	3.54	110	4.33	-	-	130	5.11	130	5.11
Center to Top Open	Class 150/300	C	-	-	-	170	6.69	195	7.67	203	7.99	-	-	243	9.56	262	10.3
	Class 600	C	-	-	-	148	5.82	163	6.41	178	7.00	-	-	243	9.56	262	10.3
Dia. of Port	D	-	-	-	-	10	0.39	14	0.55	19	0.75	-	-	30	1.18	37	1.45
Approx. Weight	Class 150	Kg / Lb	-	-	-	3.4	7.5	3.8	8.3	5.7	12.5	-	-	9.7	21.4	13.2	29.1
	Class 300	Kg / Lb	-	-	-	3.9	8.6	5	11.0	6.2	13.6	-	-	17	36.4	16.5	36.3
	Class 600	Kg / Lb	-	-	-	4	8.8	5.2	11.4	7.5	16.5	-	-	15	33.0	20.5	45.1

End to End dimensions according to ASME B16.10

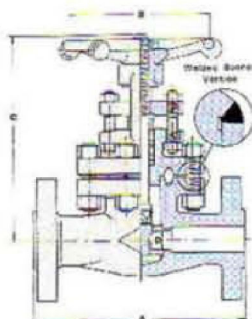

RATINGS: Carbon Steel
 Class 150 - 285 p.s.i. @ 100°F
 Class 300 - 740 p.s.i. @ 100°F
 Class 600 - 1480 p.s.i. @ 100°F

CLASS 150-300-600

ROUND BOLTED BONNET - FULL PORT - BS 5352
 Outside Screw & Yoke - Integral Flanged Ends according to ASME B16.5

FULL PORT		1/4		3/8		1/2		3/4		1		1.1/4		1.1/2		2	
		mm	in.	mm	in.	mm	in.	mm	in.	mm	in.	mm	in.	mm	in.	mm	in.
Class 150 F1-610	A	-	-	-	-	108	4.25	118	4.64	127	5.00	-	-	165	6.49	178	7.00
Class 300 F3-610	A	-	-	-	-	140	5.51	153	6.02	165	6.49	-	-	191	7.51	216	8.50
Class 600 F6-RJ610	A	-	-	-	-	165	6.49	191	7.51	216	8.50	-	-	241	9.48	292	11.5
Handwheel	B	-	-	-	-	110	4.33	110	4.33	130	5.11	-	-	250	9.84	250	9.84
Center to Top Open	Class 150/300	C	-	-	-	170	6.69	195	7.67	210	8.26	-	-	267	10.3	327	12.8
	Class 600	C	-	-	-	244	9.60	268	10.5	310	12.2	-	-	391	15.4	430	16.9
Dia. of Port	D	-	-	-	-	14	0.55	19	0.75	24	0.94	-	-	37	1.45	48	1.89
Approx. Weight	Class 150	Kg / Lb	-	-	-	3.6	7.9	4.8	10.5	6.5	14.3	-	-	12	26.4	18	39.6
	Class 300	Kg / Lb	-	-	-	4.1	9.0	5.5	12.1	7.0	15.4	-	-	13	28.6	19	41.8
	Class 600	Kg / Lb	-	-	-	6	13.2	11	24.2	13	28.6	-	-	27	59.4	30	66.0

End to End dimensions according to ASME B16.10
 Spiral wound gasket joint for #150 - #300

Ring Joint gasket according to ASME B16.20 - API 6A

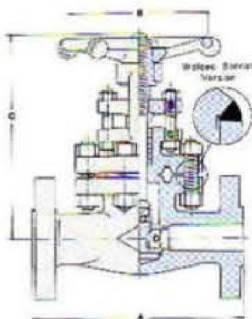

RATINGS: Carbon Steel
 Class 1500 - 3705 p.s.i. @ 100°F

CLASS 1500

ROUND BOLTED BONNET RJ - FULL PORT - BS 5352
 Outside Screw & Yoke - Integral Flanged Ends according to ASME B16.5

FULL PORT	F9-RJ910	1/4		3/8		1/2		3/4		1		1.1/4		1.1/2		2	
		mm	in.	mm	in.	mm	in.	mm	in.	mm	in.	mm	in.	mm	in.	mm	in.
End to End	A	-	-	-	-	216	8.50	229	9.01	254	10.0	-	-	305	12.0	368	14.5
Handwheel	B	-	-	-	-	110	4.33	130	5.11	130	5.11	-	-	250	9.84	300	11.8
Center to Top Open	C	-	-	-	-	260	10.2	300	11.8	300	11.8	-	-	390	15.3	420	16.5
Dia. of Port	D	-	-	-	-	14	0.55	19	0.75	24	0.94	-	-	37	1.45	48	1.89
Approx. Weight	Kg / Lb	-	-	-	-	11	24.2	16	35.2	19	41.8	-	-	35	77.1	59	130.0

End to End dimensions according to ASME B16.10
 Spiral wound gasket joint available on request

Ring Joint gasket according to ASME B16.20 - API 6A

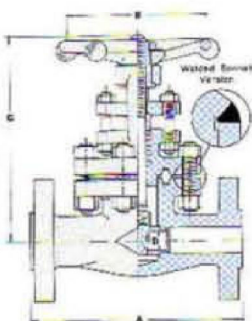

RATINGS: Carbon Steel
 Class 2500 - 6170 p.s.i. @ 100°F

CLASS 2500

ROUND BOLTED BONNET RJ - FULL PORT - B16.34
 Outside Screw & Yoke - Integral Flanged Ends according to ASME B16.5

FULL PORT	F25-RJ2510	1/4		3/8		1/2		3/4		1		1.1/4		1.1/2		2	
		mm	in.	mm	in.	mm	in.	mm	in.	mm	in.	mm	in.	mm	in.	mm	in.
End to End	A	-	-	-	-	264	10.4	273	10.7	308	12.1	-	-	384	15.1	451	17.7
Handwheel	B	-	-	-	-	130	5.11	130	5.11	250	9.84	-	-	300	11.8	300	11.8
Center to Top Open	C	-	-	-	-	304	11.9	315	12.4	368	14.5	-	-	445	17.5	538	21.2
Dia. of Port	D	-	-	-	-	14	0.55	19	0.75	24	0.94	-	-	37	1.45	37	1.45
Approx. Weight	Kg / Lb	-	-	-	-	19	41.8	21	46.2	40	88.1	-	-	62	136.5	92	202.6

End to End dimensions according to ASME B16.10

Ring Joint gasket according to ASME B16.20 - API 6A

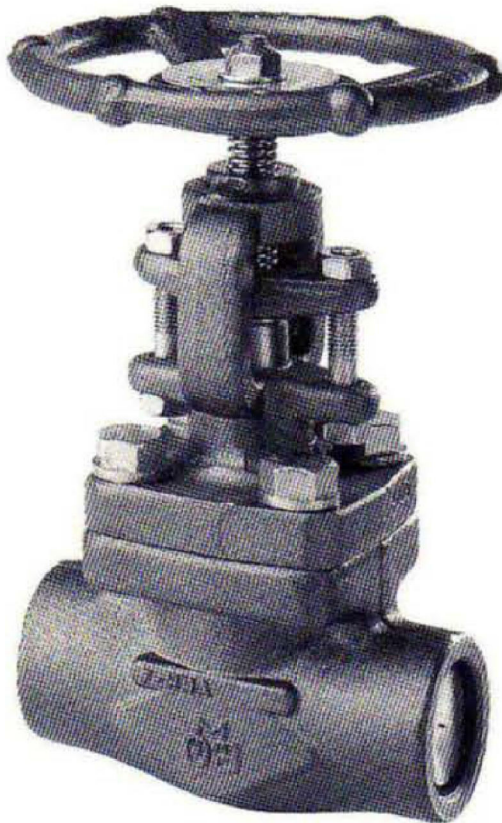

Globe valves are closing-down valves in which the closure member is moved squarely on and off the seat. In this way the opening of the port is directly proportional to the travel of the disc. This proportional relationship is ideally suited for duties requiring regulation of flow rate. To have a further precision in regulation the disc element can be available in the parabolic, needle, vee-port types. Furthermore the short travel of the disc between the open and closed position makes these valves ideally suited for on-off duties when they must be opened and closed frequently. Globe valves are unidirectional valves and are installed so that fluid pressure is under the disc. They are supplied in various models to cover the different services. Among these valves the Eco-L-Valve® combines the characteristics of total safety against leakages to the easy substitution of the most delicate components such as the bellows. The main characteristics of each type are described on pages 25 to 35.

Figure # is identified in each table as:

REGULAR PORT	830	-
FULL PORT	630	1/4 mm

Example:

FIG.# 830 - SW, 1"

COMPUTER CATALOGING CODE

PROD. LINE	SERVICE	TYPE	CLASS	SIZE	ENDS
C	A	B	8	5	S
↓	↓	↓	↓	↓	↓
Globe OS & Y	Standard	Bolted Bonnet Regular Port	800	1"	Socket Weld

PRODUCT LINE	SERVICE	TYPE	CLASS	SIZE	ENDS
C Globe OS & Y	A Standard	A Bolted Bonnet Full Port	1 150	A 1/8" (DN6)	S Socket Weld (SW)
D Globe IS & Y	B Extended Bonnet	B Bolted Bonnet Regular Port	3 300	1 1/4" (DN8)	N Threaded (NPT)
E Y Globe OS & Y	C Cryogenic	C Welded Bonnet Full Port	6 600	2 3/8" (DN10)	D Socket Weld - Threaded
F Y Globe IS & Y	L Angle	D Welded Bonnet Regular Port	8 800	3 1/2" (DN15)	E Threaded - Socket Weld
	M Jacketed	E Welded Bonnet Full Penetration Full Port	9 900	4 3/4" (DN20)	B Butt Weld - Standard End to End
	R Self-Closed	F Welded Bonnet Full Penetration Regular Port	5 1500	5 1" (DN25)	A Butt Weld - Integral End to End B16.10
	S Bellows Seal	M Ring Joint Full Port	2 2500	6 1 1/4" (DN32)	H Butt Weld - Welded End to End B16.10
	V Vacuum	N Ring Joint Regular Port	C 3000	7 1 1/2" (DN40)	F Integral Flanges R.F.
		P Round Bolted Bonnet Full Port	4 4500	8 2" (DN50)	G Integral Flanges Grove type
		Q Round Bolted Bonnet Regular Port	H 6000	9 2 1/2"	P Welded on Flanges R.F.
			E 10000	B 3"	Q Welded on Flanges Grove type
			L PN6	C 3 1/2"	C CLP - Clamp
			M PN10	D 4"	R BSP - UNI338 (BS21-Rp)
			N PN16		T BSP - UNI339 (BS21-Rc)
			P PN25		
			Q PN40		
			S PN64		
			T PN100		
			U PN160		
			V PN250		





RATINGS: Carbon Steel - 1975 p.s.i. @ 100°F

CLASS 800 BOLTED BONNET - REGULAR AND FULL PORT - BS 5352

Outside Screw & Yoke - Threaded and Socket Weld Ends

REGULAR PORT	830	-	1/2	3/4	1	1.1/4	1.1/2	2	-	
FULL PORT	630	1/4	3/8	1/2	3/4	1	1.1/4	1.1/2	2	
		mm in.	mm in.	mm in.	mm in.	mm in.	mm in.	mm in.	mm in.	mm in.
End to End	A	80 3.14	80 3.14	90 3.54	110 4.33	127 5.00	155 6.10	170 6.69	210 8.26	
Handwheel	B	70 2.75	70 2.75	90 3.54	110 4.33	130 5.11	130 5.11	180 7.08	180 7.08	
Center to Top Open	C	148 5.82	148 5.82	165 6.49	180 7.08	213 8.38	248 9.76	257 10.1	370 14.5	
Dia. of Port	D	7 0.28	9 0.35	13 0.51	17.5 0.69	22.5 0.89	29.5 1.16	35 1.37	45.5 1.79	
Approx. Weight	Kg / Lb	1.7 3.7	1.7 3.7	2.3 5.0	3.6 7.9	5.5 12.1	7.5 16.5	11.6 25.5	22.0 48.5	



RATINGS: Carbon Steel - 1975 p.s.i. @ 100°F

CLASS 800 WELDED BONNET - REGULAR AND FULL PORT - BS 5352

Outside Screw & Yoke - Threaded and Socket Weld Ends

REGULAR PORT	L830	-	1/2	3/4	1	1.1/4	1.1/2	2	-
FULL PORT	L630	1/4	3/8	1/2	3/4	1	1.1/4	1.1/2	2
		mm in.	mm in.	mm in.	mm in.	mm in.	mm in.	mm in.	mm in.
End to End	A	80 3.14	80 3.14	90 3.54	110 4.33	127 5.00	155 6.10	170 6.69	210 8.26
Handwheel	B	70 2.75	70 2.75	90 3.54	110 4.33	130 5.11	130 5.11	180 7.08	180 7.08
Center to Top Open	C	148 5.82	148 5.82	165 6.49	180 7.08	213 8.38	248 9.76	257 10.1	370 14.5
Dia. of Port	D	7 0.28	9 0.35	13 0.51	17.5 0.69	22.5 0.89	29.5 1.16	35 1.37	45.5 1.79
Approx. Weight	Kg / Lb	1.7 3.7	1.7 3.7	2.3 5.0	3.6 7.9	5.5 12.1	7.3 16	10.5 23.1	17.5 38.5

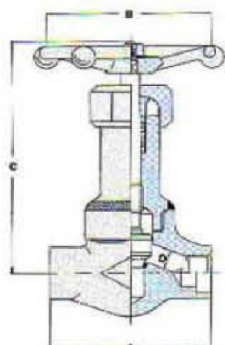

RATINGS: Carbon Steel - 1975 p.s.i. @ 100°F

CLASS 800 WELDED BONNET - REGULAR AND FULL PORT - BS 5352

Inside Screw - Threaded and Socket Weld Ends

REGULAR PORT	L820	-	1/2	3/4	1	1.1/4	1.1/2	2	-
FULL PORT	L620	1/4	3/8	1/2	3/4	1	1.1/4	1.1/2	2
		mm in.	mm in.	mm in.	mm in.	mm in.	mm in.	mm in.	mm in.
End to End	A	80 3.14	80 3.14	90 3.54	110 4.33	127 5.00	155 6.10	170 6.69	210 8.26
Handwheel	B	70 2.75	70 2.75	90 3.54	110 4.33	130 5.11	130 5.11	180 7.08	180 7.08
Center to Top Open	C	148 5.82	148 5.82	175 6.88	212 8.34	235 9.25	287 11.3	327 12.9	380 15.0
Dia. of Port	D	7 0.28	9 0.35	13 0.51	17.5 0.69	22.5 0.89	29.5 1.16	35 1.37	45.5 1.79
Approx. Weight	Kg / Lb	1.5 3.3	1.5 3.3	2.0 4.4	3.7 8.1	5.5 12.1	7.3 16	10.5 23.1	17.5 38.5

Bolted Bonnet Type on request



RATINGS: Carbon Steel - 3705 p.s.i. @ 100°F

CLASS 1500 BOLTED BONNET - REGULAR AND FULL PORT - BS 5352

Outside Screw & Yoke - Threaded and Socket Weld Ends

REGULAR PORT	R930	-	1/2	3/4	1	1.1/4	1.1/2	2	-
FULL PORT	930	1/4	3/8	1/2	3/4	1	1.1/4	1.1/2	2
		mm in.	mm in.	mm in.	mm in.	mm in.	mm in.	mm in.	mm in.
End to End	A	90 3.54	90 3.54	110 4.33	127 5.00	155 6.10	170 6.69	210 8.26	210 8.26
Handwheel	B	90 3.54	90 3.54	110 4.33	130 5.11	130 5.11	180 7.08	180 7.08	180 7.08
Center to Top Open	C	160 6.29	160 6.29	175 6.88	210 8.26	244 9.60	250 9.84	370 14.5	375 14.7
Dia. of Port	D	7 0.28	9 0.35	13 0.51	17 0.67	21 0.83	28 1.10	33 1.30	37.5 1.48
Approx. Weight	Kg / Lb	2.2 4.8	2.2 4.8	3.9 8.5	6 13.2	8 17.6	12 26.4	23.5 51.7	23 50.6

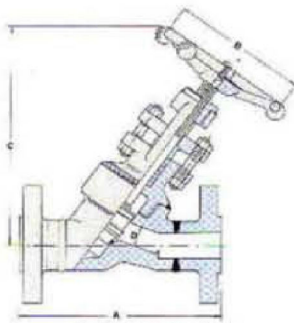

RATINGS: Carbon Steel
 Class 150 - 285 p.s.i. @ 100°F
 Class 300 - 740 p.s.i. @ 100°F
 Class 600 - 1480 p.s.i. @ 100°F

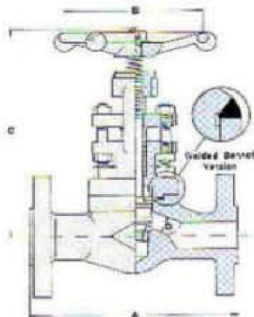

RATINGS: Carbon Steel
 Class 150 - 285 p.s.i. @ 100°F
 Class 300 - 740 p.s.i. @ 100°F
 Class 600 - 1480 p.s.i. @ 100°F

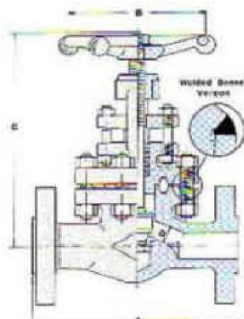

RATINGS: Carbon Steel
 Class 150 - 285 p.s.i. @ 100°F
 Class 300 - 740 p.s.i. @ 100°F
 Class 600 - 1480 p.s.i. @ 100°F

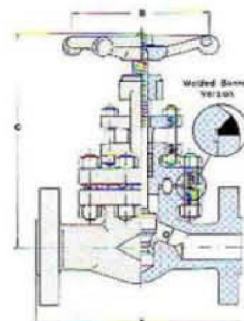

RATINGS: Carbon Steel
 Class 1500 - 3705 p.s.i. @ 100°F
 Class 2500 - 6170 p.s.i. @ 100°F

CLASS 150-300-600

WELDED BONNET - FULL PORT - BS 5352

Outside Screw & Yoke - Flanged Ends according to ASME B16.5

FULL PORT		1/4		3/8		1/2		3/4		1		1.1/4		1.1/2		2	
		mm	in.	mm	in.	mm	in.	mm	in.	mm	in.	mm	in.	mm	in.	mm	in.
Class 150	1-Y630	A	-	-	-	108	4.25	118	4.64	127	5.00	-	-	165	6.49	203	7.99
Class 300	3-Y630	A	-	-	-	153	6.02	178	7.00	203	7.99	-	-	229	9.01	267	10.5
Class 600	6-Y630	A	-	-	-	165	6.49	191	7.51	216	8.50	-	-	241	9.48	292	11.5
	Handwheel	B	-	-	-	90	3.54	110	4.33	130	5.11	-	-	180	7.08	180	7.08
	Center to Top Open	C	-	-	-	155	6.10	175	6.88	220	8.66	-	-	280	11.0	350	13.78
	Dia. of Port	D	-	-	-	13	0.51	17.5	0.68	22.5	0.88	-	-	35	1.37	45.5	1.79
Approx. Weight	Class 150	Kg / Lb		-	-	3.2	7.04	4	8.8	7.2	15.8	-	-	14.9	32.8	19	41.8
	Class 300	Kg / Lb		-	-	4.2	9.25	5.7	12.5	10.7	23.5	-	-	16.4	36.1	21	46.2
	Class 600	Kg / Lb		-	-	4.7	10.3	6	13.2	11.7	25.7	-	-	17.4	38.3	23	50.6

End to End dimensions according to ASME B16.10

CLASS 150-300-600

BOLTED BONNET - REGULAR PORT - BS 5352

Outside Screw & Yoke - Integral Flanged Ends according to ASME B16.5

REGULAR PORT		1/4		3/8		1/2		3/4		1		1.1/4		1.1/2		2	
		mm	in.	mm	in.	mm	in.	mm	in.	mm	in.	mm	in.	mm	in.	mm	in.
Class 150	F1-830	A	-	-	-	108	4.25	118	4.64	127	5.00	-	-	165	6.49	203	7.99
Class 300	F3-830	A	-	-	-	153	6.02	178	7.00	203	7.99	-	-	229	9.01	267	10.5
Class 600	F6-830	A	-	-	-	165	6.49	191	7.51	216	8.50	-	-	241	9.48	292	11.5
	Handwheel	B	-	-	-	90	3.54	90	3.54	110	4.33	-	-	130	5.11	180	7.08
	Center to Top Open	C	-	-	-	148	5.82	165	6.49	180	7.08	-	-	248	9.76	257	10.1
	Class 300-600	C	-	-	-	170	6.69	197	7.75	205	8.07	-	-	248	9.76	257	10.1
	Class 150	C	-	-	-	170	6.69	197	7.75	205	8.07	-	-	248	9.76	257	10.1
	Dia. of Port	D	-	-	-	9	0.35	13	0.51	17.5	0.69	-	-	29.5	1.16	35	1.37
Approx. Weight	Class 150	Kg / Lb		-	-	3.4	7.5	4	8.8	5.7	12.5	-	-	10	22.0	17.0	37.4
	Class 300	Kg / Lb		-	-	4	8.8	5	11.0	7.3	16.1	-	-	14	30.8	20.5	45.1
	Class 600	Kg / Lb		-	-	4.5	9.9	5.5	12.1	7.6	16.7	-	-	15	33.0	21	46.2

End to End dimensions according to ASME B16.10

CLASS 150-300-600

BOLTED BONNET - FULL PORT - BS 5352

Outside Screw & Yoke - Integral Flanged Ends according to ASME B16.5

FULL PORT		1/4		3/8		1/2		3/4		1		1.1/4		1.1/2		2	
		mm	in.	mm	in.	mm	in.	mm	in.	mm	in.	mm	in.	mm	in.	mm	in.
Class 150	F1-630	A	-	-	-	108	4.25	118	4.64	127	5.00	-	-	165	6.49	203	7.99
Class 300	F3-RJ630	A	-	-	-	153	6.02	178	7.00	203	7.99	-	-	229	9.01	267	10.5
Class 600	F6-RJ630	A	-	-	-	165	6.49	191	7.51	216	8.50	-	-	241	9.48	292	11.5
	Handwheel	B	-	-	-	110	4.33	110	4.33	130	5.11	-	-	250	9.84	250	9.84
	Center to Top Open	C	-	-	-	245	9.64	273	10.7	295	11.6	-	-	410	16.1	440	17.3
	Class 300-600	C	-	-	-	170	6.69	200	7.87	250	9.84	-	-	285	11.2	320	12.6
	Class 150	C	-	-	-	170	6.69	200	7.87	250	9.84	-	-	285	11.2	320	12.6
	Dia. of Port	D	-	-	-	13	0.51	17.5	0.69	22.5	0.89	-	-	35	1.37	45.5	1.79
Approx. Weight	Class 150	Kg / Lb		-	-	4.2	9.2	5.5	12.1	7.5	16.5	-	-	13.5	29.7	21	46.2
	Class 300	Kg / Lb		-	-	5.8	12.8	10.8	23.8	12.8	28.2	-	-	26.5	58.4	29	63.9
	Class 600	Kg / Lb		-	-	6	13.2	11	24.2	13	28.6	-	-	27	59.4	30	66.0

End to End dimensions according to ASME B16.10
 Spiral wound gasket joint for #150

Ring-Joint gasket according to ASME B16.20 - API 6A

CLASS 1500-2500

ROUND BOLTED BONNET RJ - FULL PORT - BS 5352 - B16.34

Outside Screw & Yoke - Integral Flanged Ends according to ASME B16.5

FULL PORT		1/4		3/8		1/2		3/4		1		1.1/4		1.1/2		2	
		mm	in.	mm	in.	mm	in.	mm	in.	mm	in.	mm	in.	mm	in.	mm	in.
Class 1500	F9-RJ930	A	-	-	-	216	8.50	229	9.01	254	10.0	-	-	305	12.0	368	14.5
Class 2500	F25-RJ2530	A	-	-	-	264	10.4	273	10.7	308	12.1	-	-	384	15.1	451	17.7
	Handwheel	B	-	-	-	110	4.33	130	5.11	130	5.11	-	-	250	9.84	300	11.8
	Class 1500	B	-	-	-	130	5.11	130	5.11	250	9.84	-	-	300	11.8	300	11.8
	Class 2500	B	-	-	-	130	5.11	130	5.11	250	9.84	-	-	300	11.8	300	11.8
	Center to Top Open	C	-	-	-	260	10.2	300	11.8	300	11.8	-	-	390	15.3	420	16.5
	Class 1500	C	-	-	-	332	13.0	331	13.0	370	14.5	-	-	435	17.1	570	22.4
	Class 2500	C	-	-	-	332	13.0	331	13.0	370	14.5	-	-	435	17.1	570	22.4
	Dia. of Port	D	-	-	-	13	0.51	17	0.67	21	0.83	-	-	33	1.30	37.5	1.48
	Class 1500	D	-	-	-	11	0.43	17	0.67	21	0.83	-	-	33	1.30	37.5	1.48
Approx. Weight	Class 1500	Kg / Lb		-	-	11	24.2	16	35.2	19.5	42.9	-	-	34	74.8	61	134.3
	Class 2500	Kg / Lb		-	-	19.5	42.9	21.5	47.3	42	92.5	-	-	65	143.2	95	209.2

End to End dimensions according to ASME B16.10
 For class 1500 spiral wound gasket joint available on request

Ring-Joint gasket according to ASME B16.20 - API 6A



Check valves are uni-directional valves which automatically open with forward flow and close against reverse flow.

They are supplied to meet a wide variety of applications with the closing element in the piston, ball or swing type. Piston check valves are normally supplied by OMB with the addition of a spring which allows both the vertical and horizontal installation.

Great care is given by OMB employees in the design and in manufacturing to prevent noisy operation and unsatisfactory wear of closure components.

The full range of OMB production is reported on pages 37 to 42.



Figure # is identified in each table as:

REGULAR PORT	PISTON 840 BALL 850 SWING 860	
FULL PORT	PISTON 840 BALL 850 SWING 860	1/4"

Example:

FIG.# 844 - SW
COMPUTER CATALOGING CODE

PROD. LINE	SERVICE	TYPE	CLASS	SIZE	ENDS
G	P	A	8	4	S
↓	↓	↓	↓	↓	↓
Check Valve	Piston	Bolted Bonnet Full Port	800	3/4"	Socket Weld

PRODUCT LINE	SERVICE	TYPE	CLASS	SIZE	ENDS
G Check Valve	B Ball C Y Ball M Jacketed N Self Draining P Piston Q Y Piston S Swing	A Bolted Bonnet Full Port B Bolted Bonnet Regular Port C Welded Bonnet Full Port D Welded Bonnet Regular Port E Welded Bonnet Full Penetration Full Port F Welded Bonnet Full Penetration Regular Port M Ring Joint Full Port N Ring Joint Regular Port P Round Bolted Bonnet Full Port Q Round Bolted Bonnet Regular Port	1 150 3 300 6 600 8 800 9 900 2 2500 4 4500 H 6000 E 10000 L PN6 M PN10 N PN16 P PN25 Q PN40 S PN64 T PN100 U PN160 V PN250	A 1/8" (DN6) 1 1/4" (DN8) 2 3/8" (DN10) 3 1/2" (DN15) 4 3/4" (DN20) 5 1" (DN25) 6 1 1/4" (DN32) 7 1 1/2" (DN40) 8 2" (DN50) 9 2 1/2" B 3" C 3 1/2" D 4"	S Socket Weld (SW) N Threaded (NPT) D Socket Weld - Threaded E Threaded - Socket Weld B Butt Weld - Standard End to End A Butt Weld - Integral End to End B16.10 H Butt Weld - Welded End to End B16.10 F Integral Flanges R.F. G Integral Flanges Grove type P Welded on Flanges R.F. Q Welded on Flanges Grove type C CLP - Clamp R BSP - UNI338 (BS21-Rp) T BSP - UNI339 (BS21-Rc)

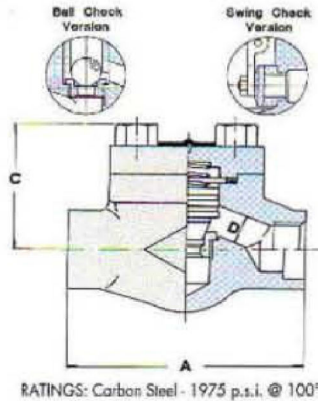

RATINGS: Carbon Steel - 1975 p.s.i. @ 100°F

CLASS 800

PISTON, BALL AND SWING TYPE - REGULAR AND FULL PORT - BS 5352
Bolted Cover - Threaded and Socket Weld Ends

REGULAR PORT		PISTON 840 BALL 850 SWING 860	-	1/2	3/4	1	1.1/4	1.1/2	2	-								
FULL PORT		PISTON 640 BALL 650 SWING 660	1/4	3/8	1/2	3/4	1	1.1/4	1.1/2	2								
End to End	PISTON-BALL	A	80	3.14	80	3.14	90	3.54	110	4.33	127	5.00	155	6.10	170	6.69	210	8.26
	SWING	A	80	3.14	80	3.14	90	3.54	110	4.33	127	5.00	127	5.00	127	5.00	210	8.26
Center to Top		C	53	2.08	53	2.08	60	2.36	73	2.87	80	3.14	98	3.85	118	4.64	150	5.90
Dia. of Port	PISTON-BALL	D	7	0.28	9	0.35	13	0.51	17.5	0.69	22.5	0.88	29.5	1.16	35	1.38	45.5	1.79
	SWING	D	8	0.31	10	0.39	14	0.55	19	0.75	24	0.94	30	1.18	37	1.45	48	1.89
Approx. Weight	PISTON-BALL	Kg / Lb	1.3	2.8	1.3	2.8	1.4	3.0	2.4	5.2	4.0	8.8	7.4	16.2	8	17.6	18	39.6
	SWING	Kg / Lb	1.3	2.8	1.3	2.8	1.4	3.0	2.4	5.2	4.0	8.8	5.5	12.1	6.5	14.3	17.5	38.5

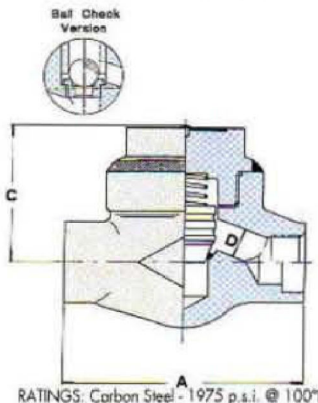

RATINGS: Carbon Steel - 1975 p.s.i. @ 100°F

CLASS 800

PISTON AND BALL TYPE - REGULAR AND FULL PORT - BS 5352
Welded Cover - Threaded and Socket Weld Ends

REGULAR PORT		PISTON 1840 BALL 1850	-	1/2	3/4	1	1.1/4	1.1/2	2	-								
FULL PORT		PISTON 1640 BALL 1650	1/4	3/8	1/2	3/4	1	1.1/4	1.1/2	2								
End to End	A		80	3.14	80	3.14	90	3.54	110	4.33	127	5.00	155	6.10	170	6.69	210	8.26
	C		53	2.08	53	2.08	60	2.36	73	2.87	80	3.14	98	3.85	110	4.33	150	5.90
Dia. of Port	D		7	0.28	9	0.35	13	0.51	17.5	0.69	22.5	0.88	29.5	1.16	35	1.37	45.5	1.79
	Kg / Lb		1.3	2.8	1.3	2.8	1.4	3.0	2.4	5.2	4.0	8.8	7.4	16.3	8	17.6	17	37.4

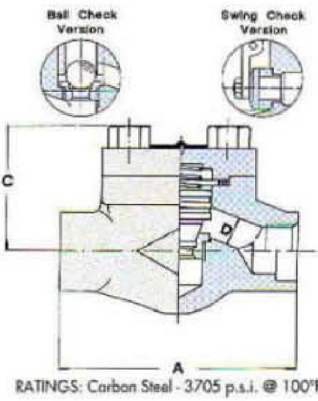

RATINGS: Carbon Steel - 3705 p.s.i. @ 100°F

CLASS 1500

PISTON, BALL AND SWING TYPE - REGULAR AND FULL PORT - BS 5352
Bolted Cover - Threaded and Socket Weld Ends

REGULAR PORT		PISTON R040 BALL R950 SWING R960	-	1/2	3/4	1	1.1/4	1.1/2	2	-								
FULL PORT		PISTON 940 BALL 950 SWING 960	1/4	3/8	1/2	3/4	1	1.1/4	1.1/2	2								
End to End	PISTON-BALL	A	90	3.54	90	3.54	110	4.33	127	5.00	155	6.10	170	6.69	210	8.26	210	8.26
	SWING	A	90	3.54	90	3.54	110	4.33	127	5.00	127	5.00	127	5.00	210	8.26	210	8.26
Center to Top		C	60	2.36	60	2.36	73	2.87	80	3.14	98	3.85	118	4.64	150	5.90	150	5.90
Dia. of Port	PISTON-BALL	D	7	0.28	9	0.35	13	0.51	17.5	0.69	21	0.83	28	1.10	33	1.30	37.5	1.48
	SWING	D	8	0.31	10	0.39	14	0.55	19	0.75	24	0.94	30	1.18	37	1.45	40	1.57
Approx. Weight	PISTON-BALL	Kg / Lb	1.5	3.3	1.5	3.3	2.8	6.1	4.6	10.1	7.4	16.2	9	19.8	19.5	42.9	19	41.8
	SWING	Kg / Lb	1.6	3.5	1.5	3.3	2.4	5.2	4	8.8	6	13.2	9.5	20.9	19	41.8	18.5	40.7

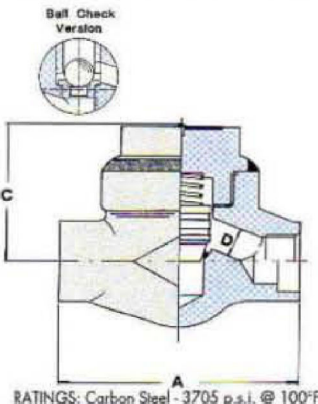

RATINGS: Carbon Steel - 3705 p.s.i. @ 100°F

CLASS 1500

PISTON AND BALL TYPE - REGULAR AND FULL PORT - BS 5352
Welded Cover - Threaded and Socket Weld Ends

REGULAR PORT		PISTON 18940 BALL 18950	-	1/2	3/4	1	1.1/4	1.1/2	2	-								
FULL PORT		PISTON 1640 BALL 1650	1/4	3/8	1/2	3/4	1	1.1/4	1.1/2	2								
End to End	A		90	3.54	90	3.54	110	4.33	127	5.00	155	6.10	170	6.69	210	8.26	210	8.26
	C		60	2.36	60	2.36	73	2.87	80	3.14	98	3.85	110	4.33	150	5.90	150	5.90
Dia. of Port	D		7	0.28	9	0.35	13	0.51	17	0.67	21	0.83	28	1.10	33	1.30	37.5	1.47
	Kg / Lb		1.5	3.3	1.5	3.3	2.8	6.1	4.6	10.1	7.4	16.3	9	19.8	15	33.0	14.5	31.9



CHECK VALVES FORGED STEEL

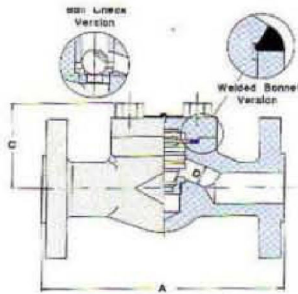

RATINGS: Carbon Steel
 Class 150 - 285 p.s.i. @ 100°F
 Class 300 - 740 p.s.i. @ 100°F
 Class 600 - 1480 p.s.i. @ 100°F

CLASS 150-300-600

PISTON AND BALL TYPE - REGULAR PORT - BS 5352
 Bolted Cover - Integral Flanged Ends according to ASME B16.5

REGULAR PORT		1/4		3/8		1/2		3/4		1		1.1/4		1.1/2		2	
		mm	in.	mm	in.	mm	in.	mm	in.	mm	in.	mm	in.	mm	in.	mm	in.
Class 150	PISTON F1-840 BALL F1-850	A	-	-	-	108	4.25	118	4.64	127	5.00	-	-	165	6.49	203	7.99
Class 300	PISTON F3-840 BALL F3-850	A	-	-	-	153	6.02	178	7.00	203	7.99	-	-	229	9.01	267	10.5
Class 600	PISTON F6-840 BALL F6-850	A	-	-	-	165	6.49	191	7.51	216	8.50	-	-	241	9.48	292	11.5
Center to Top Open	Class 150	C	-	-	-	75	2.95	92	3.62	98	3.85	-	-	98	3.85	110	4.33
	Class 300-600	C	-	-	-	53	2.08	60	2.36	73	2.87	-	-	98	3.85	110	4.33
Dia. of Port		D	-	-	-	9	0.35	13	0.51	17.5	0.69	-	-	29.5	1.16	35	1.37
Approx. Weight	Class 150	Kg/Lb	-	-	-	2.9	6.4	3.2	7.0	4.3	9.5	-	-	6.5	14.3	14.5	31.9
	Class 300	Kg/Lb	-	-	-	3.6	7.9	4.2	9.2	6	13.2	-	-	12	26.4	16	35.2
	Class 600	Kg/Lb	-	-	-	4.1	9.0	4.7	10.4	6.3	13.8	-	-	13	28.6	17	37.4

End to End dimensions according to ASME B16.10

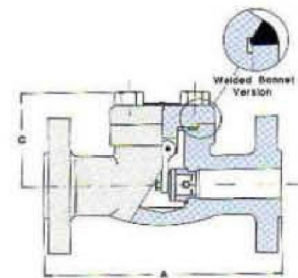

RATINGS: Carbon Steel
 Class 150 - 285 p.s.i. @ 100°F
 Class 300 - 740 p.s.i. @ 100°F
 Class 600 - 1480 p.s.i. @ 100°F

CLASS 150-300-600

SWING TYPE - REGULAR PORT - BS 5352
 Bolted Cover - Integral Flanged Ends according to ASME B16.5

REGULAR PORT		1/4		3/8		1/2		3/4		1		1.1/4		1.1/2		2	
		mm	in.	mm	in.	mm	in.	mm	in.	mm	in.	mm	in.	mm	in.	mm	in.
Class 150	F1-860	A	-	-	-	108	4.25	118	4.64	127	5.00	-	-	165	6.49	203	7.99
Class 300	F3-860	A	-	-	-	153	6.02	178	7.00	216	8.50	-	-	241	9.48	267	10.5
Class 600	F6-860	A	-	-	-	165	6.49	191	7.51	216	8.50	-	-	241	9.48	292	11.5
Center to Top Open	Class 150	C	-	-	-	75	2.95	92	3.62	98	3.85	-	-	98	3.85	110	4.33
	Class 300-600	C	-	-	-	53	2.08	60	2.36	73	2.87	-	-	98	3.85	110	4.33
Dia. of Port		D	-	-	-	10	0.39	14	0.55	19	0.75	-	-	30	1.18	37	1.45
Approx. Weight	Class 150	Kg/Lb	-	-	-	2.9	6.4	3.2	7.0	4.3	9.5	-	-	6.5	14.3	14.5	31.9
	Class 300	Kg/Lb	-	-	-	3.6	7.9	4.2	9.2	6.1	13.4	-	-	13	28.6	16	35.2
	Class 600	Kg/Lb	-	-	-	4.1	9.0	4.7	10.4	6.3	13.8	-	-	13	28.6	17	37.4

End to End dimensions according to ASME B16.10

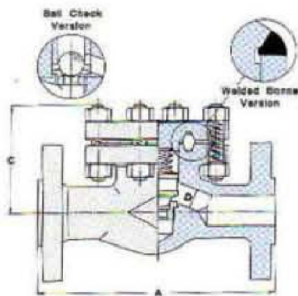

RATINGS: Carbon Steel
 Class 150 - 285 p.s.i. @ 100°F
 Class 300 - 740 p.s.i. @ 100°F
 Class 600 - 1480 p.s.i. @ 100°F

CLASS 150-300-600

PISTON AND BALL TYPE - FULL PORT - BS 5352
 Round Bolted Cover - Integral Flanged Ends according to ASME B16.5

FULL PORT		1/4		3/8		1/2		3/4		1		1.1/4		1.1/2		2	
		mm	in.	mm	in.	mm	in.	mm	in.	mm	in.	mm	in.	mm	in.	mm	in.
Class 150	PISTON F1-840 BALL F1-850	A	-	-	-	108	4.25	118	4.64	127	5.00	-	-	165	6.49	203	7.99
Class 300	PISTON F3-RJ840 BALL F3-RJ850	A	-	-	-	153	6.02	178	7.00	203	7.99	-	-	229	9.01	267	10.5
Class 600	PISTON F6-RJ840 BALL F6-RJ850	A	-	-	-	165	6.49	191	7.51	216	8.50	-	-	241	9.48	292	11.5
Center to Top Open	Class 150	C	-	-	-	75	2.95	100	3.93	110	4.33	-	-	120	4.72	147	5.78
	Class 300-600	C	-	-	-	115	4.52	130	5.11	140	5.51	-	-	170	6.69	195	7.67
Dia. of Port		D	-	-	-	13	0.51	17.5	0.69	22.5	0.89	-	-	35	1.37	45.5	1.79
Approx. Weight	Class 150	Kg/Lb	-	-	-	3.2	7.0	3.5	7.7	4.6	10.1	-	-	7.0	15.4	16	35.2
	Class 300	Kg/Lb	-	-	-	4.6	10.1	6.1	13.4	9.1	20.0	-	-	16	35.2	21	46.2
	Class 600	Kg/Lb	-	-	-	4.8	10.5	6.3	13.8	9.3	20.5	-	-	16.5	36.3	22	48.4

End to End dimensions according to ASME B16.10

Spiral wound gasket joint for #150

Ring-joint gasket according to ASME B16.20 - API 6A

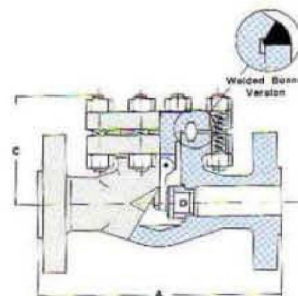

RATINGS: Carbon Steel
 Class 150 - 285 p.s.i. @ 100°F
 Class 300 - 740 p.s.i. @ 100°F
 Class 600 - 1480 p.s.i. @ 100°F

CLASS 150-300-600

SWING TYPE - FULL PORT - BS 5352
 Bolted Cover - Integral Flanged Ends according to ASME B16.5

FULL PORT		1/4		3/8		1/2		3/4		1		1.1/4		1.1/2		2	
		mm	in.	mm	in.	mm	in.	mm	in.	mm	in.	mm	in.	mm	in.	mm	in.
Class 150	F1-660	A	-	-	-	108	4.25	118	4.64	127	5.00	-	-	165	6.49	203	7.99
Class 300	F3-RJ660	A	-	-	-	153	6.02	178	7.00	216	8.50	-	-	241	9.48	267	10.5
Class 600	F6-RJ660	A	-	-	-	165	6.49	191	7.51	216	8.50	-	-	241	9.48	292	11.5
Center to Top Open	Class 150	C	-	-	-	75	2.95	100	3.93	110	4.33	-	-	120	4.72	147	5.78
	Class 300-600	C	-	-	-	115	4.52	130	5.11	140	5.51	-	-	170	6.69	195	7.67
Dia. of Port		D	-	-	-	14	0.55	19	0.75	24	0.94	-	-	37	1.45	48	1.89
Approx. Weight	Class 150	Kg/Lb	-	-	-	3.1	6.8	3.4	7.5	4.5	9.9	-	-	6.8	14.9	15.7	34.5
	Class 300	Kg/Lb	-	-	-	4.6	10.1	6.1	13.4	9.3	20.5	-	-	16.5	36.3	21	46.2
	Class 600	Kg/Lb	-	-	-	4.8	10.5	6.3	13.8	9.3	20.5	-	-	16.5	36.3	22	48.4

End to End dimensions according to ASME B16.10

Spiral wound gasket joint for #150

Ring-joint gasket according to ASME B16.20 - API 6A



FLOW COEFFICIENT C_v

The C_v is a valve property and is defined as follows: "The Flow Coefficient C_v is the flow capacity of a valve in U.S. gallons per minute of water at a standard temperature of 60°F (15.6° C) that will flow through the valve with a pressure loss of one pound per square inch at a specific opening position". For the metric system the equivalent value is K_v where measure unit are Bar, Kg and meters. The C_v show the quality and accuracy of a valve in terms of pressure loss, the highest values of C_v indicate the highest quality of a valve.

The values shown

VALVE SIZE	GATE		GLOBE			CHECK		
	Regular Port	Full Port	Regular Port	Full Port	Y Pattern	Regular Port	Full Port	Y Pattern
1/4	-	2.5	-	1.1	2.9	-	0.9	2.3
3/8	-	4.3	-	1.4	3.8	-	1.1	3.5
1/2	5.5	11.6	1.5	3.6	4.5	1	2.1	4.8
3/4	12	26.6	3.8	6.6	10.1	2.8	5.8	7.8
1	27	54.6	6.8	10.9	16.0	6	7	11.2
1 1/4	55	79.8	11	14	23.1	9.5	9.2	18.0
1 1/2	80	87	14.3	24.3	47.1	11	15.4	37.8
2	105.0	203	25	39.7	80.2	18	32	69.2

FLOW-RATE

$$Q = C_v \sqrt{\frac{\Delta p}{S}}$$

PRESSURE DROP

$$\Delta p = S \left(\frac{Q}{C_v} \right)^2$$

For liquids other than water

Δp = Pressure drop (p.s.i.).

Q = Liquid flow in gallons per minute (GPM).

S = Specific gravity of liquid relative to water (60°F).

C_v = Valves flow coefficient.

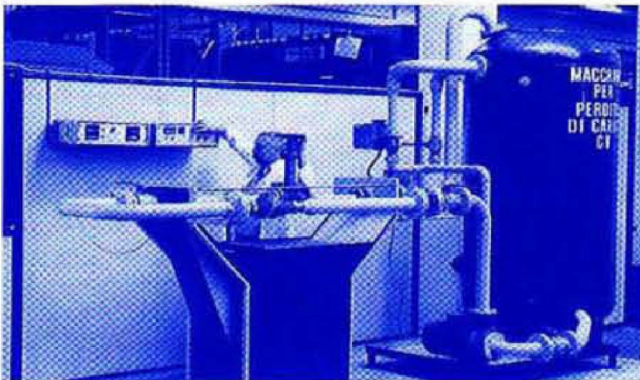

To measure the properly value of C_v there is not a standard method. OMB R & D team has used two different methods: 1-Using C_v definition, through the means of a specifically built test rig, it has been obtained 1 Bar of pressure loss and the flow has been verified with specific equipment. Calculation is possible to convert the measure to C_v . 2-In the same machine the flow has been changed and different measure of pressure loss has been obtained: a table has been defined and an average value per each valve has been calculated.

MANUAL REQUEST

(send a copy of this page with your request to +39.035.942638):

OMB GGC

Install and Maintenance

OMB Bellows Seal Valve

Install and Maintenance

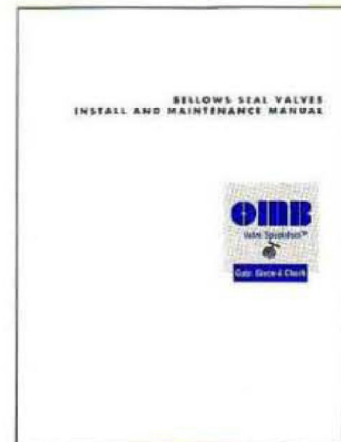
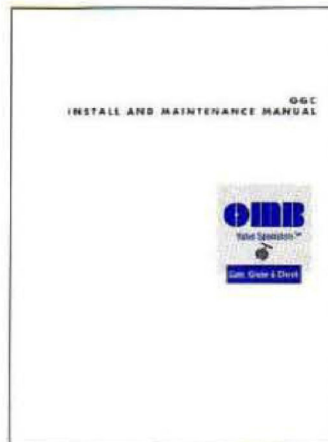

GATE VALVE

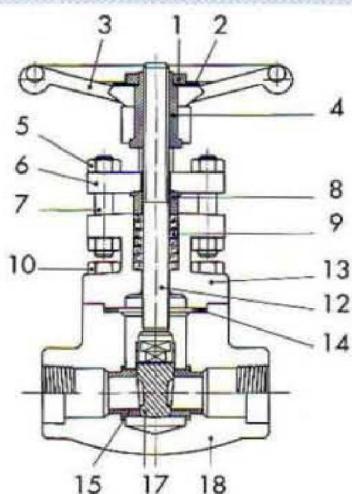

- 1 WHEELNUT
- 2 NAMEPLATE
- 3 HANDWHEEL
- 4 YOKE NUT
- 5 GLAND NUT
- 6 GLAND FLANGE
- 7 GLAND STUD
- 8 GLAND
- 9 PACKING
- 10 BOLTS
- 12 STEM
- 13 BONNET
- 14 GASKET
- 15 SEAT
- 17 WEDGE
- 18 BODY

GLOBE VALVE

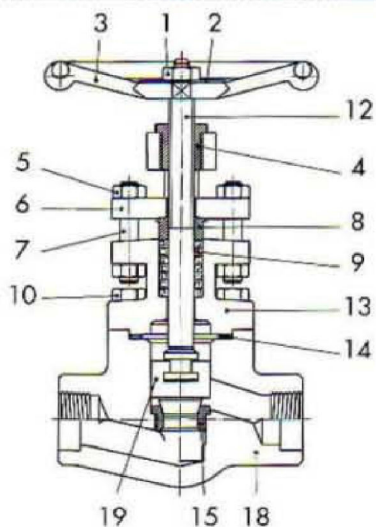

- 1 WHEELNUT
- 2 NAMEPLATE
- 3 HANDWHEEL
- 4 YOKE NUT
- 5 GLAND NUT
- 6 GLAND FLANGE
- 7 GLAND STUD
- 8 GLAND
- 9 PACKING
- 10 BOLTS
- 12 STEM
- 13 BONNET
- 14 GASKET
- 15 SEAT
- 18 BODY
- 19 DISC

CHECK VALVE

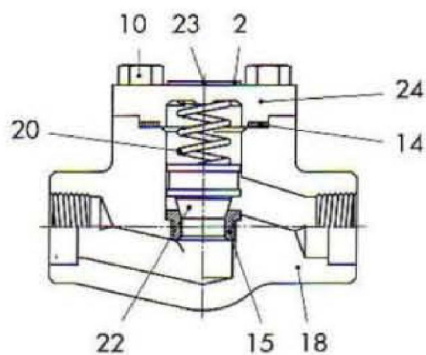

- 2 NAMEPLATE
- 10 BOLTS
- 14 GASKET
- 15 SEAT
- 18 BODY
- 20 SPRING
- 22 PISTON
- 23 RIVET
- 24 CAP

GATE VALVE

	A105/F6	A105/F6HFS	LF2/304	F11/F6HFS	F304/304	F316/316
Wheelnut	Carbon Steel	Carbon Steel	Carbon Steel	Carbon Steel	Carbon Steel	Carbon Steel
Nameplate	Aluminium	Aluminium	Aluminium	Aluminium	Aluminium	Aluminium
Handwheel	Carbon Steel	Carbon Steel	Carbon Steel	Carbon Steel	Carbon Steel	Carbon Steel
Yoke Nut	416	416	416	416	303	303
Gland Nut	2H	2H	GR8	GR8	GR8	GR8
Gland Flange	A105	A105	LF2	F11	F304	F316
Gland Stud	410	410	B8	B8	B8	B8
Gland	316L	316L	316L	316L	316L	316L
Packing (*)	Graphite	Graphite	Graphite	Graphite	Graphite	Graphite
Bolts	B7	B7	L7	B16	B8	B8
Stem	410	410	304	410	304	316
Bonnet	A105	A105	LF2	F11	F304	F316
Gasket	Sp. Wound	Sp. Wound	Sp. Wound	Sp. Wound	Sp. Wound	Sp. Wound
Seat	410	410HF	410HF	410HF	304	316
Wedge	F6	F6	F304	F6	F304	F316
Body	A105	A105	LF2	F11	F304	F316

GLOBE VALVE

	A105/F6	A105/F6HFS	LF2/304	F11/F6HFS	F304/304	F316/316
Wheelnut	Carbon Steel	Carbon Steel	Carbon Steel	Carbon Steel	Carbon Steel	Carbon Steel
Nameplate	Aluminium	Aluminium	Aluminium	Aluminium	Aluminium	Aluminium
Handwheel	Carbon Steel	Carbon Steel	Carbon Steel	Carbon Steel	Carbon Steel	Carbon Steel
Yoke Nut	416	416	416	416	303	303
Gland Nut	2H	2H	GR8	GR8	GR8	GR8
Gland Flange	A105	A105	LF2	F11	F304	F316
Gland Stud	410	410	B8	B8	B8	B8
Gland	316L	316L	316L	316L	316L	316L
Packing (*)	Graphite	Graphite	Graphite	Graphite	Graphite	Graphite
Bolts	B7	B7	L7	B16	B8	B8
Stem	410	410	304	410	304	316
Bonnet	A105	A105	LF2	F11	F304	F316
Gasket	Sp. Wound	Sp. Wound	Sp. Wound	Sp. Wound	Sp. Wound	Sp. Wound
Seat	410	410HF	410HF	410HF	304	316
Disc	410	410	304	410	304	316
Body	A105	A105	LF2	F11	F304	F316

CHECK VALVE

	A105/F6	A105/F6HFS	LF2/304	F11/F6HFS	F304/304	F316/316
Nameplate	Aluminium	Aluminium	Aluminium	Aluminium	Aluminium	Aluminium
Bolts	B7	B7	L7	B16	B8	B8
Gasket	Sp. Wound	Sp. Wound	Sp. Wound	Sp. Wound	Sp. Wound	Sp. Wound
Seat	410	410HF	410HF	410HF	304	316
Body	A105	A105	LF2	F11	F304	F316
Spring	Stainless Steel	Stainless Steel	Stainless Steel	Stainless Steel	Stainless Steel	Stainless Steel
Piston	410	410	304	410	304	316
Rivet	Carbon Steel	Carbon Steel	Carbon Steel	Carbon Steel	Carbon Steel	Carbon Steel
Cap	A105	A105	LF2	F11	F304	F316

(*) = Packing: Low Emission Packing Available on Request